



## Heat recovery air handling units

# KOMFORT L

Air capacity – up to 2200 m<sup>3</sup>/h  
Heat recovery efficiency – up to 88 %



### ■ Application

- Air handling units for efficient supply and exhaust ventilation in flats, houses, cottages and other buildings.
- Heat recovery minimises ventilation heat losses.
- Control of air exchange for creating comfortable indoor microclimate.
- Compatible with round Ø125 to 315 mm air ducts.

### ■ Design

- The casing is made of aluminium profile and double-skinned aluzinc panels, internally filled with mineral wool layer for heat and sound insulation.
- The casing has fixing brackets with vibration absorbing connectors for easy installation.
- The spigots for connection to the air ducts are located at the side of the unit and are rubber sealed for airtight connection to the air ducts.
- The hinged casing side panels ensure easy access to the internals for cleaning, filter replacement and other maintenance operations.

### ■ Fans

- Asynchronous external rotor motors and centrifugal double-intake impellers with forward curved blades are used for air supply and exhaust.
- Integrated motor overheating protection with automatic restart.
- Dynamically balanced impellers.
- Equipped with ball bearings for longer service life.
- Reliable and quiet operation.

### ■ Heat recovery

- The unit is equipped with a cross-flow aluminium heat exchanger with a large surface area and high heat recovery efficiency.
- The air flows are fully separated within the heat exchanger. Odours and contaminants contained in the extract air are not transferred to the supply air flow.
- Heat recovery is based on the utilization of the thermal energy of the extract air for heating up supply air. Extract air transfers most of its heat to the intake air flow. Heat recovery reduces heat losses in cold seasons. In summer the heat exchanger performs reverse and intake air is cooled

in the heat exchanger by the cool extract air. This contributes to better performance of the air conditioner in ventilated premises.

- The built-in freezing protection system automatically turns the supply fan off in case of a freezing danger to enable warming of the heat exchanger with the warm extract air flow. When a freezing danger is over the the supply fan is turned on and the unit reverts to previous operation mode.
- The drain pan under the heat exchanger block is used for condensate collection and drainage.
- Heat recovery is not useful in warm season with small indoor and outdoor temperature difference. In this case the heat exchanger may be temporary replaced with a summer block (available separately).

### ■ Air filtration

- Two built-in G4 cassette filters provide efficient supply and extract air filtration. Optionally, an F7 supply filter may be used (special accessory).





### ■ Control and automation

- Speed control by means of the four-position speed switch CDP-3/5 that enables setting low, medium, maximum speed and turning the unit off.

### ■ Mounting

- Mounting to floor, ceiling or wall with fixing brackets.
- The correct mounted unit must provide condensate collecting and drainage and free access to the hinged side panel for servicing and filter replacement.

## Technical data

Parameters	KOMFORT L350 	KOMFORT L500 	KOMFORT L530 	KOMFORT L600 	KOMFORT L1200	KOMFORT L2200
Voltage [V]	1 ~ 230 / 50-60 Hz				1 ~ 230 / 50 Hz	1 ~ 230 / 50-60 Hz
Power [kW]	0.26	0.3	0.3	0.39	0.82	1.3
Current [A]	1.2	1.32	1.32	1.72	3.6	5.68
Air capacity [m <sup>3</sup> /h]	350	500	530	600	1200	2200
RPM	1150	1100	1100	1350	1850	1150
Sound pressure level at 3 m [dBA]	24-45	28-47	28-47	32-48	60	65
Transported air temperature [°C]	-25 up to 55	-25 up to 50		-25 up to 55	-25 up to 40	
Casing material	aluzinc					
Insulation	25 mm mineral wool				50 mm mineral wool	
Extract filter	cassette G4					
Supply filter	cassette F7				cassette G4 (F7)*	
Connected air duct diameter [mm]	125	150	160	200	250	315
Weight [kg]	45	49	49	54	85	96
Heat recovery efficiency [%]**	up to 78	up to 88		up to 85	up to 88	up to 87
Heat exchanger type	cross-flow					
SEC class***	E				-	-
Heat exchanger material	aluminum					

\*Option.

\*\* Heat recovery efficiency is specified in compliance with the EN308 EU norms.

\*\*\* The EC norm 1254/2014 does not apply if maximum air capacity is >1000 m<sup>3</sup>/h

## Overall dimensions

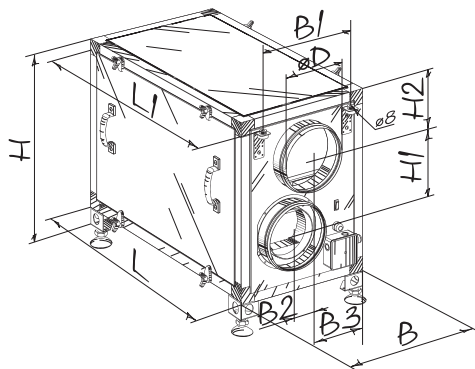

Model	Dimensions [mm]									
	ØD	B	B1	B2	B3	H	H1	H2	L	L1
KOMFORT L350	124	416	300	54	207	603	230	148	722	768
KOMFORT L500	149	416	300	54	207	603	230	148	722	768
KOMFORT L530	159	416	300	54	207	603	230	148	722	768
KOMFORT L600	199	416	300	54	207	603	230	148	722	768
KOMFORT L1200	248	548	496	60	213	794	290	200	802	850
KOMFORT L2200	313	846	796	235	588	968	360	246	1000	1050

## Accessories

Model	Replaceable filter G4 (cassette)	Replaceable filter F7 (cassette)	Summer block
KOMFORT L350	FP-L350-600 G4	FP-L350-600 F7	SB-L350
KOMFORT L500			SB-L500-600
KOMFORT L530			
KOMFORT L600			
KOMFORT L1200	FP-L1200 G4	FP-L1200 F7	SB-L1200
KOMFORT L2200	FP-L2200 G4	FP-L2200 F7	SB-L2200

■ Technical data

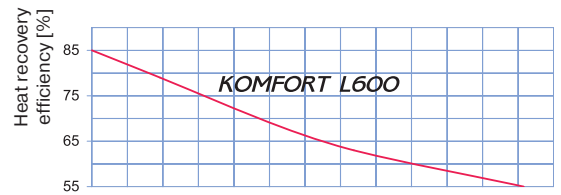
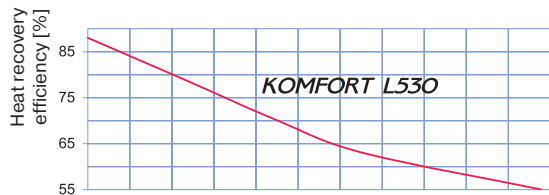
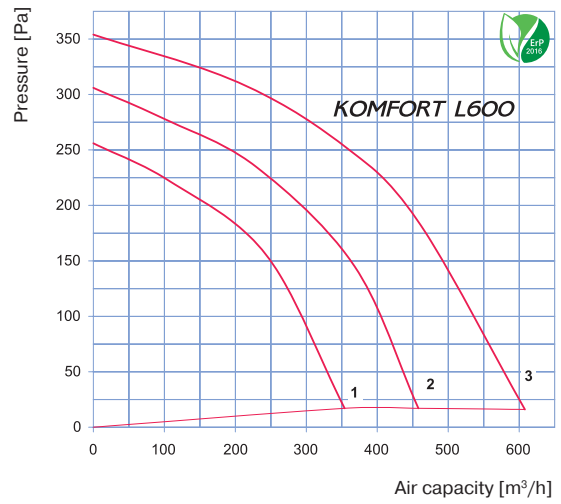
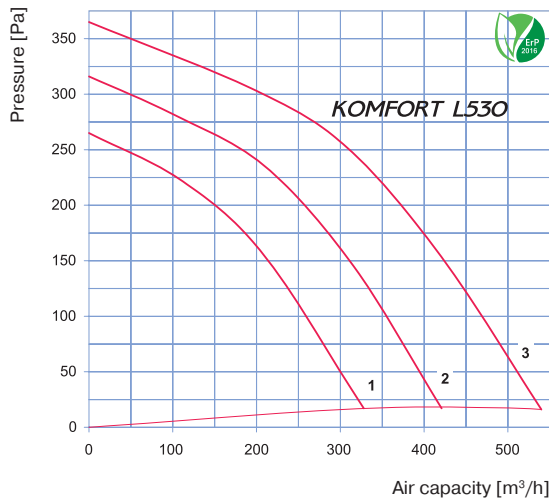
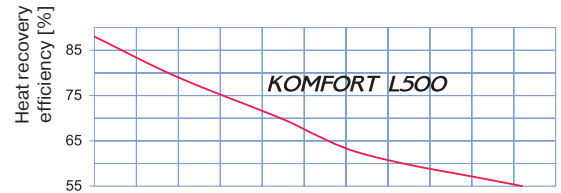
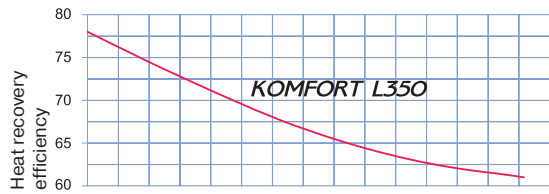
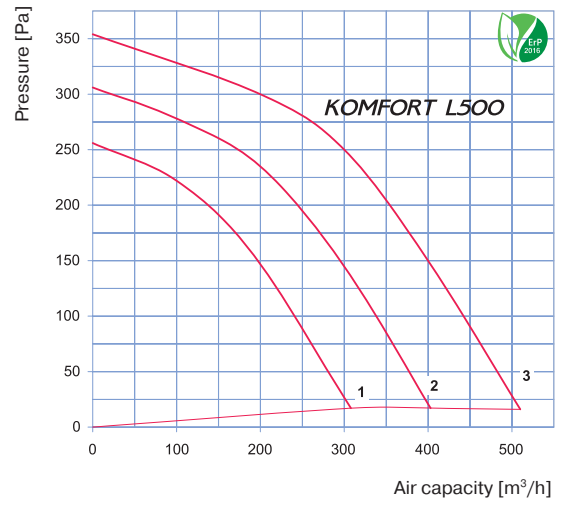
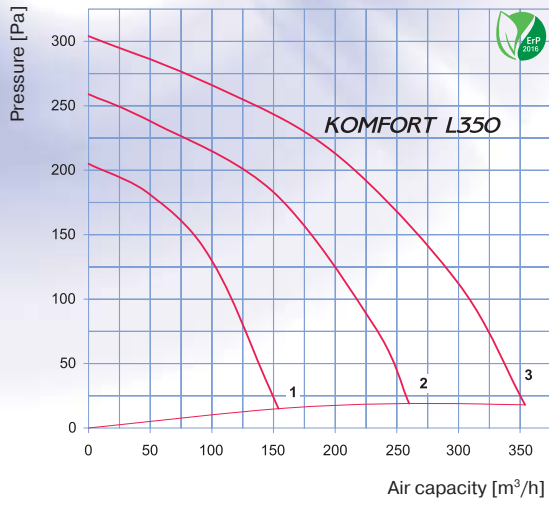

■ **Technical data**

